

### Description

The WX Series is a replacement front module to replace Legacy A2T Series such as the PanelLink15 and PanelLink17.

The WX15 is the Legacy front assembly and the PIX is most similar to the older PanelLink chassis. It utilizes a bracket mount for panel mounting in conjunction with the PIX chassis.

### Key Features

- PIX chassis models are available with 0, 1 or 3 PCI Slots
- Drop in replacement of Legacy panelink15 and Panelink17
- Low/Medium Power with Mini-ITX board



### Specifications

WX MONITOR DISPLAY		
SPECS	WX15	WX17
Display Size	15.1" TFT LCD	17.1" TFT LCD
Resolution	XGA 1024 x 768	SXGA 1280 x 1024
Viewing Angle	H:-70°/+70°,V:-65°/+70°	H:-70°/+70°,V:-65°/+70°
Contrast Ratio	700:1	800:1
Brightness	350 nits	300 nits
Bulb Life	CCFT Back Life estimated to be about 50,000 hours	
Interface Lens	5-Wire analog resistive touch sensor OR Protective lexan lens	
Mounting Bezel	NEMA 4 Powder coated aluminum OR NEMA 4X stainless steel	
Warranty	24 Month Limited Warranty. Extended warranty available, contact us for more details	

PIX CHASSIS MODULES			
SPECS	PIX0	PIX1 / PIXE	PIX3
Expansion Slots	0 PCI Slots	1 PCI / 1 PCI Express	3 PCI Slots
System	<b>Mini-ITX Intel GM45:</b> Up to 4Gb DDR2, 1xPCI, 4xUSB, 5x RS232, 2x Ethernet, 1x PS/2, DVI, VGA, HDMI		
	<b>Mini-ITX Intel Atom:</b> 2x Ethernet Intel 1 Gb Ports, 4x USB 2.0, 2x RS232, Audio I/O		
CPU	Core Solo Mobile, Core Duo Mobile, Core 2 Duo Mobile, Atom		
Operating System	Windows XP Pro, Windows XP Embedded, Windows 2000, Windows Vista, Windows 7, ROMDOS		
Memory	1.0Gb to 2Gb DDR or DDR2		
Storage Drives	2.5" SATA or PATA Hard Drives / 2.5" Solid State Drives / Industrial Compact Flash Cards		
Media Drives	Slim DVD/DVD-RW/CD/CD-RW (Mounting depth is increased 0.60" with rear mounted thin CD/DVD Drive *)		
Power Supply	1U 120~240 VAC Power Supply or Open Frame Fanless 24VDC Power Supply		
Temperature	0°~50°C (32°~122°F) Operating / -25°~60°C (-4°~140°F) Non-Operating		
Relative Humidity	10% ~ 95% Non-Condensing		
Shock	10G Operating / 15G Non-Operating		
Vibration	1.0G from 57-2000 Hz Operating / 2.5G from 57-2000 Hz Non-Operating		
Warranty	24 Month Limited Warranty. Extended Warranty Available, Contact Us For More Details		

\* Rear mounting increases only for PIX0, PIX1 & PIXE. PIX3 CD/DVD drive is integrated in chassis.

### Dimensions



#### DISPLAY FRONT DIMENSIONS

	WX15	WX17
Height	12.1"	14.1"
Width	15.3"	17.1"

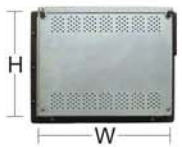

#### PANEL CUTOUT DIMENSIONS

	WX15	WX17
Height	11.3"	13.1"
Width	14.6"	16.1"

#### WORKSTATION WEIGHTS

	PIX0	PIX1 / PIXE	PIX3
WX15	18.35 lbs	20.80 lbs	24.95 lbs
WX17	21.47 lbs	24.11 lbs	28.08 lbs

#### MOUNTING DEPTH DIMENSIONS

	PIX0	PIX1 / PIXE	PIX3
WX15	4.0"	4.8"	6.2"
WX17	3.9"	4.8"	6.2"

\* CD/DVD rear mounting increases by 0.60" only for PIX0, PIX1 & PIXE. PIX3 CD/DVD drive is integrated in chassis.

### Mechanical Drawing

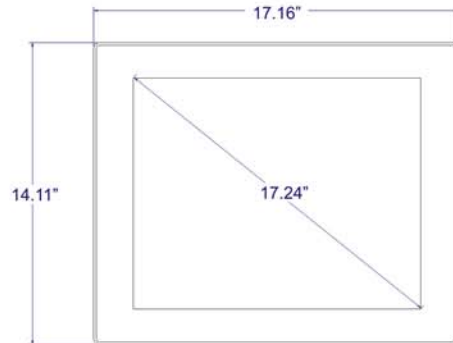
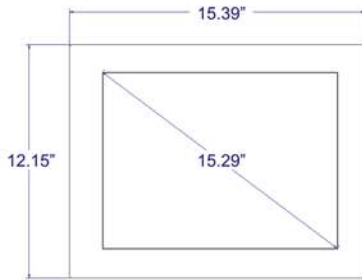

WX15-PIX0

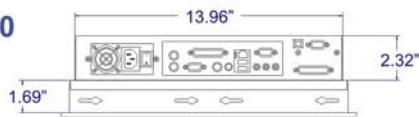

WX17-PIX0

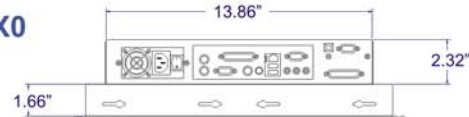

WX15-PIX1

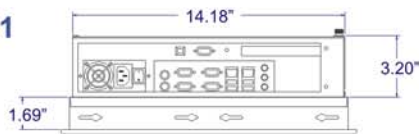

WX17-PIX1

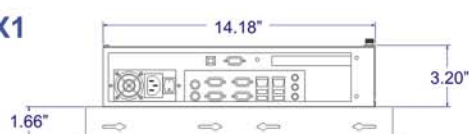

WX15-PIX3

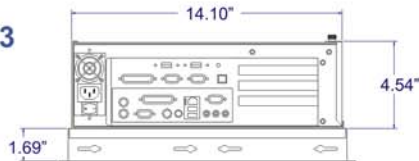

WX17-PIX3

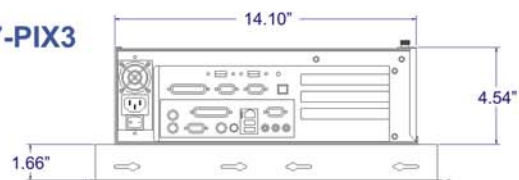

All measurements are in inches and pounds, unless noted. Picture and drawing Estimated weight may change depending on additional options. Dynics reserves the right to change, modify, upgrade or discontinue to its dis

For more i